

NA4910-2RSR-XL

Needle roller bearing

Schaeffler ID:
0507752600000

Needle roller bearings NA49..-2RSR,
dimension series 49, lip seals on both
sides

X-life

Technical information

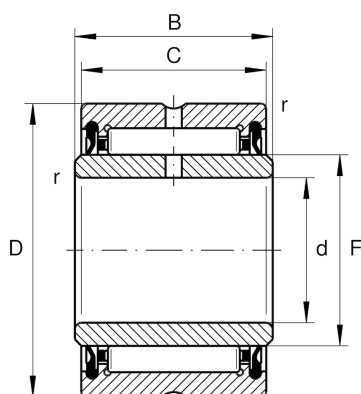

Main Dimensions & Performance Data

d	50 mm	Bore diameter
D	72 mm	Outside diameter
B	23 mm	Width, inner ring
C_r	45,000 N	Basic dynamic load rating, radial
C_{0r}	64,000 N	Basic static load rating, radial
C_{ur}	10,800 N	Fatigue load limit, radial
$n_{G \text{ Grease}}$	4,650 1/min	Limiting speed for grease lubrication
	286.1 g	Weight

Dimensions

F	58 mm	Raceway diameter inner ring
C	22 mm	Width, outer ring
r_{\min}	0.6 mm	Minimum chamfer dimension

Temperature range

T_{\min}	-20 °C	Operating temperature min.
T_{\max}	100 °C	Operating temperature max.